

104

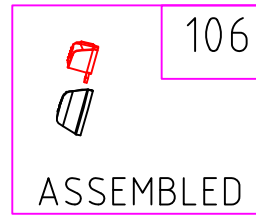

106

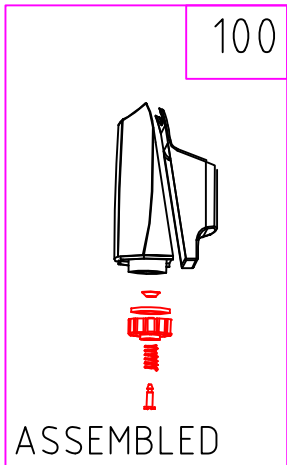
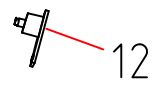

100

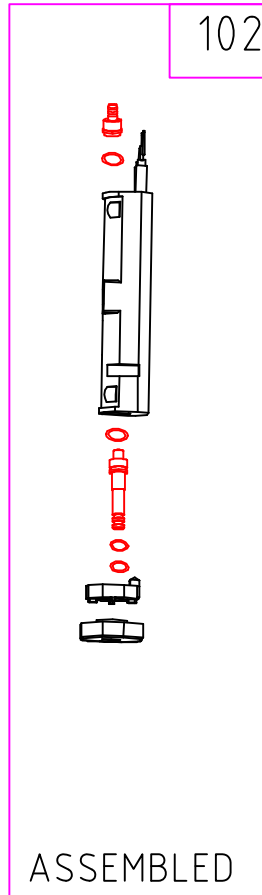
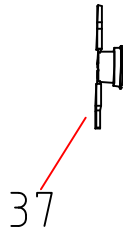

102



58



31

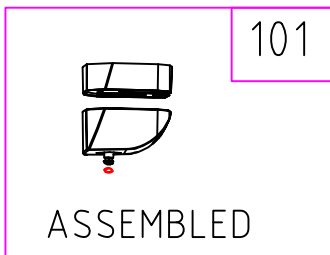

101

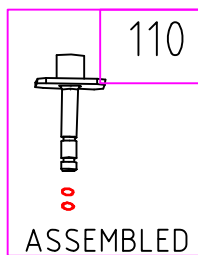

110

105

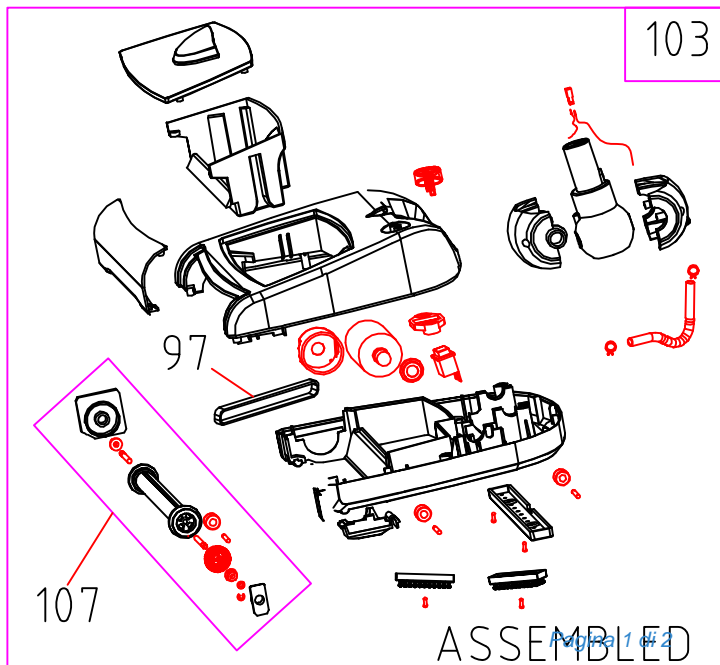
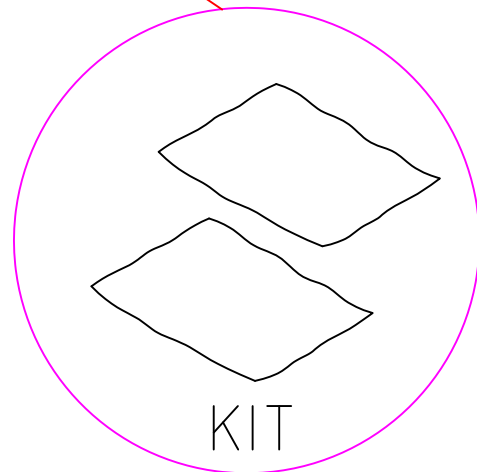

103

97

107

82

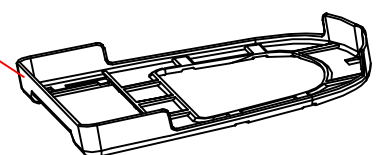

Posizione	Codice	Descrizione
05	AT5175760200	INTERRUTTORE CPU 1113 12 10 A 250V T105
12	AT5175710400	SCHEDA PCB REG.VAP. 2706
31	AT5171210030	TERMOFUSIBILE RY 10A 250V Tf240
37	AT5171420030	TERMOSTATO KSD-166 16A 250V Tf 150 4162
58	AT5171450060	POMPA JYPC-2 220-240V 50Hz 16W X 4162
82	AT5175513100	ACCESSORIO X TAPPETI GRIGIO 432C 2706
97	AT5175392800	CINGHIA DI TRASMISSIONE X SPAZZ. 2706
100	AT5176007300	ASS.SERBATOIO 2706 TRANSP.GREY
101	AT5176007400	ASS.FITLRO SER. 4163/2706
102	AT5176006400	ASS.CALDAIA 4162
103	AT5176007200	ASS.TESTA VAPORE SER.GIALLA C/SPAZZ.2706
104	AT5176007700	ASS. KIT X CHIUSURA IMPUGNATURA 2705
105	AT5176007800	KIT 2 PANNI 2706
106	AT5176007600	ASS.MANOPOLA REG.VAP.2706
107	AT5176007500	ROTARY BRUSH ASS.Y 2706
108	AT5175710500	SCHEDA PCB XL4895 2706
110	AT5176009100	ASSIEME RACCORDO 2706